

GRADE 5
Science
STAAR Alternate 2

Administered April 2019
RELEASED

SCIENCE



2a



2b

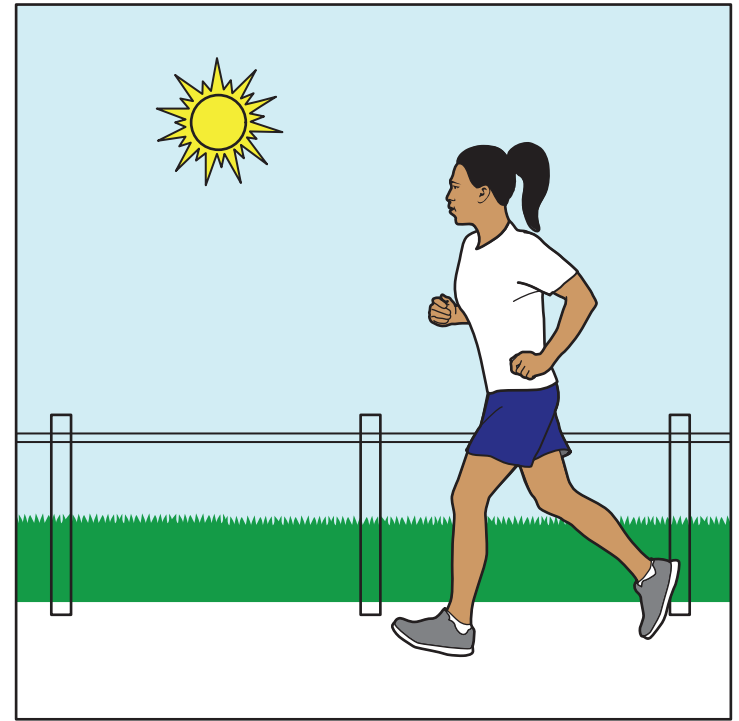

Thursday

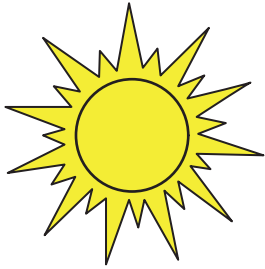

Temperature
100°F

Friday

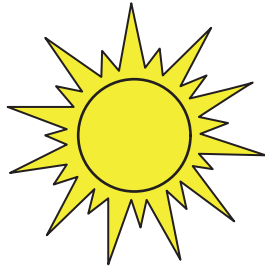

Temperature
101°F

Saturday

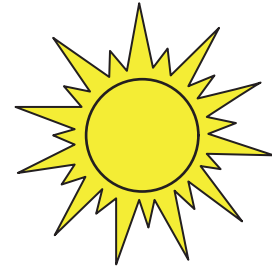

Temperature
100°F



swimming





snowboarding





splashing
in puddles

4a

Texas

March 1	March 2	March 3
		
80°F	82°F	81°F

Minnesota

March 1	March 2	March 3
		
34°F	37°F	35°F

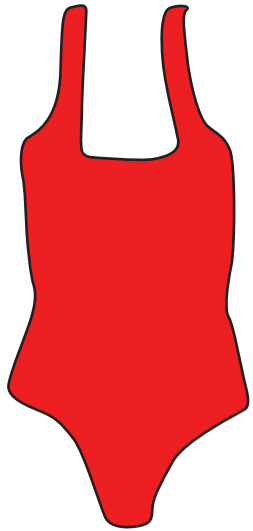

bathing
suit



winter coat

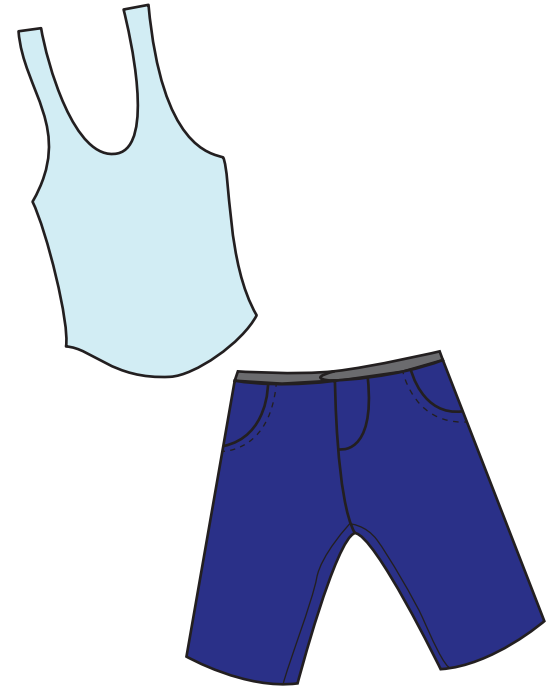

shorts and
shirt



© iStock.com/matmart



© iStock.com/CTRPhotos

6a



© iStock.com/matmart

6b



© nortongo/Bigstock.com



© Coldmoon Photoproject/Shutterstock.com

Smooth Texture



rock

© Coldmoon Photoproject/Shutterstock.com



refrigerator
door

© iStock.com/mfto



glass
mirror

© iStock.com/Firmafotografen



brick

© iStock.com/windujedi



pineapple

© Davydenko Yulija/Shutterstock.com



bowl

© SuphonPhoto/Bigstock.com

8a

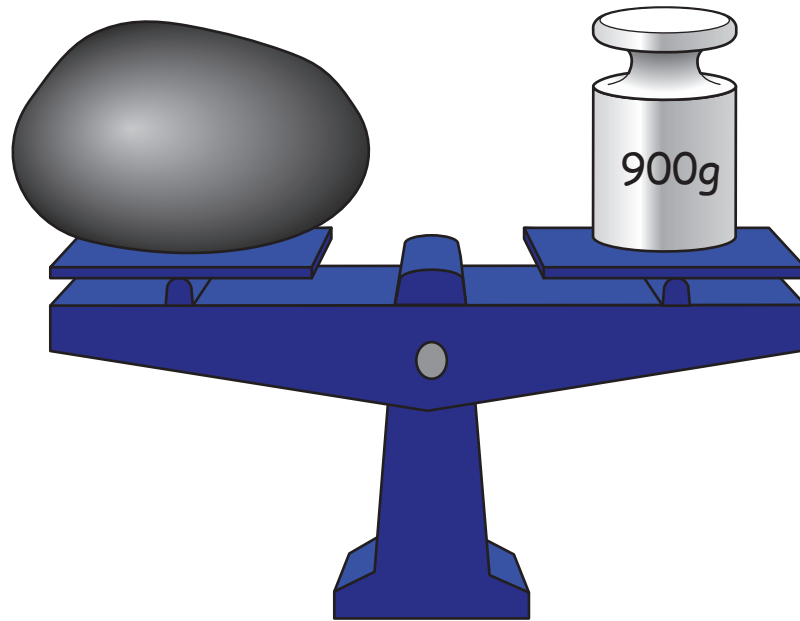

mass

temperature

magnetism

Life Cycle of a Frog

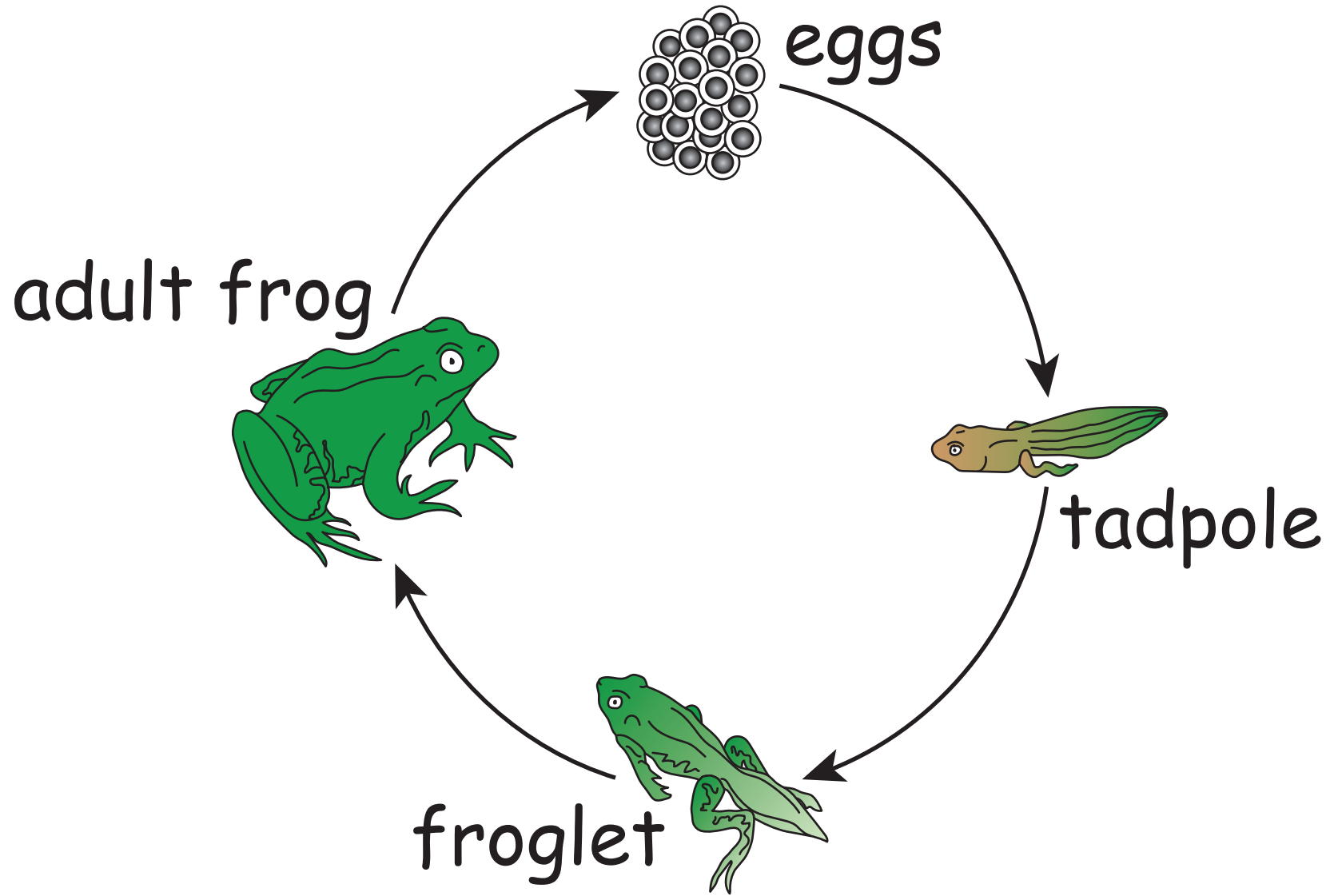

Life Cycle of a Frog

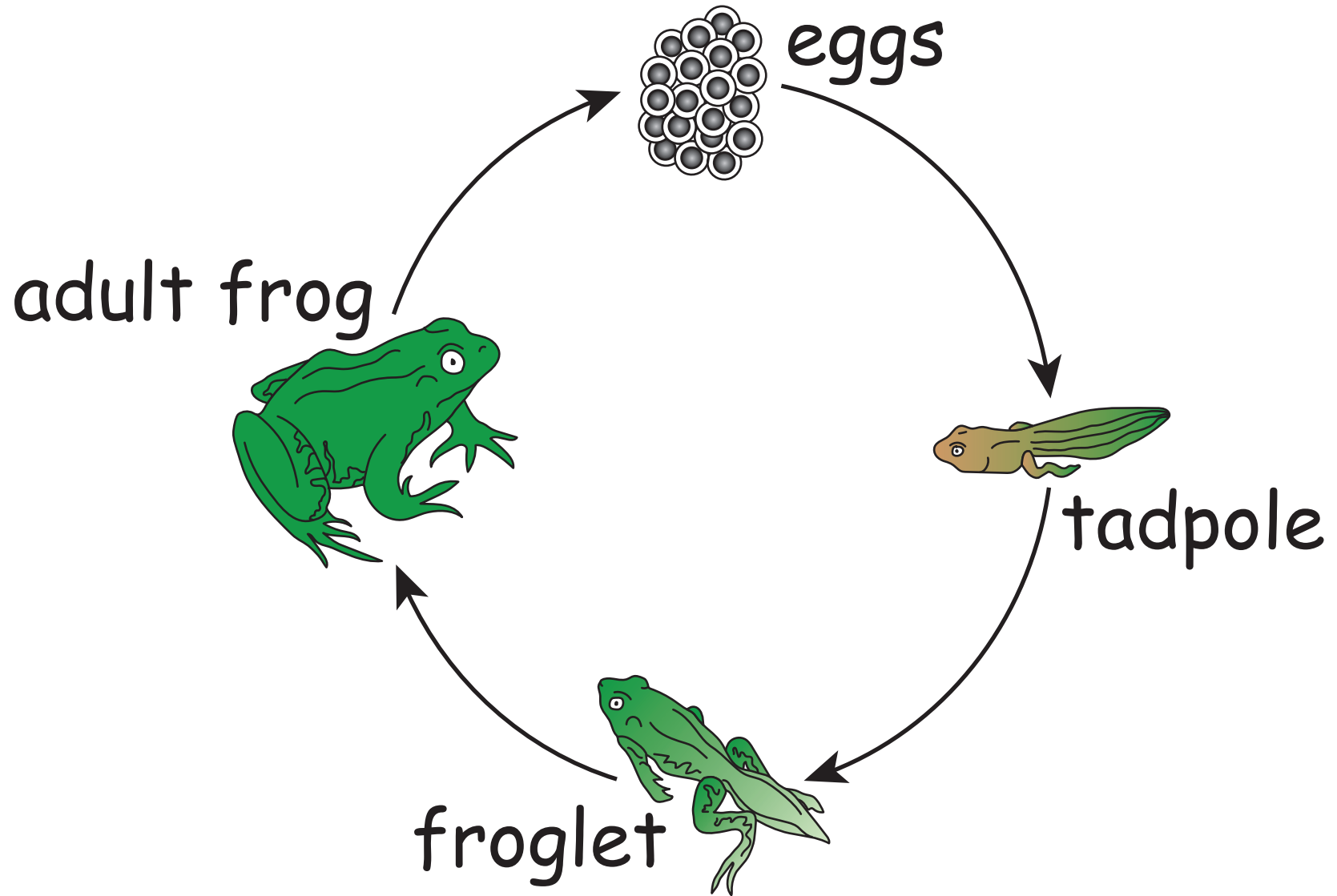

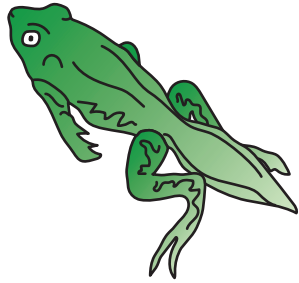

froglet



tadpole

Life Cycle of a Frog

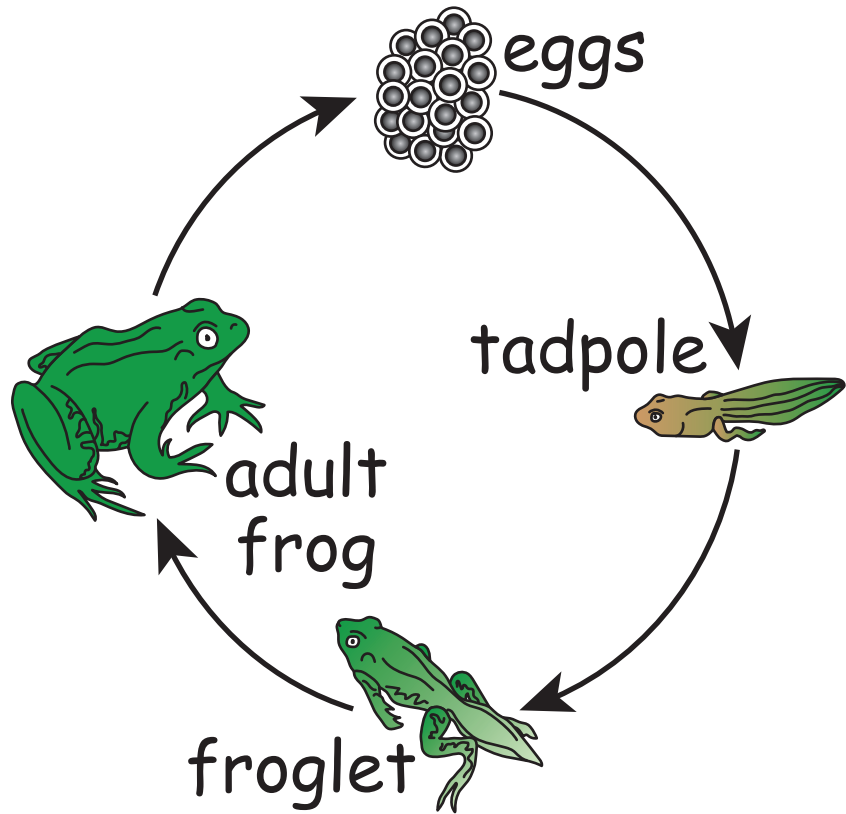

Life Cycle of a Salamander

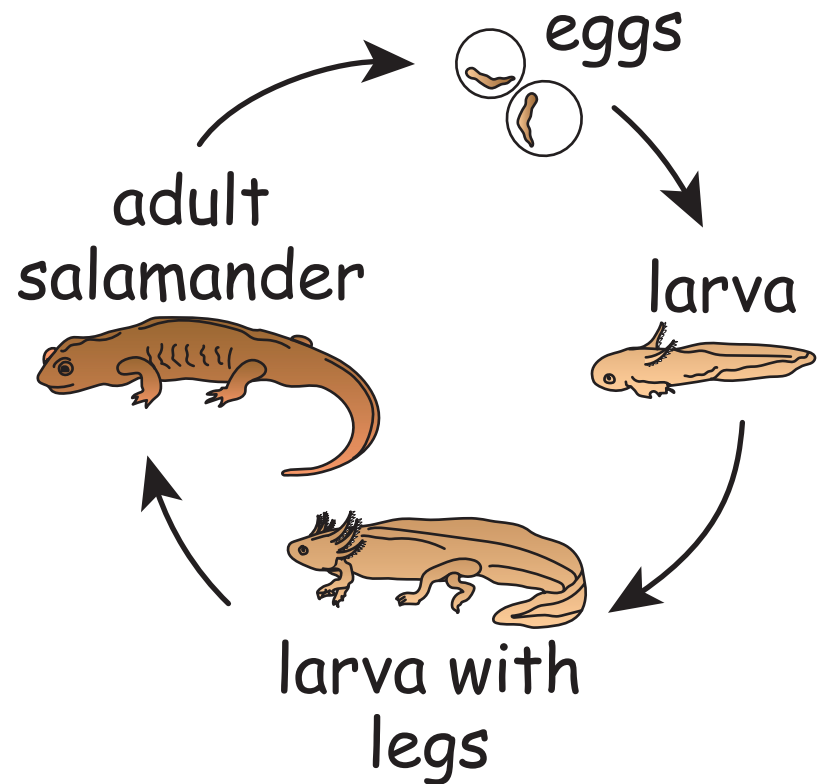

adult salamander

eggs

larva with legs

Life Cycle of a Silkworm Moth

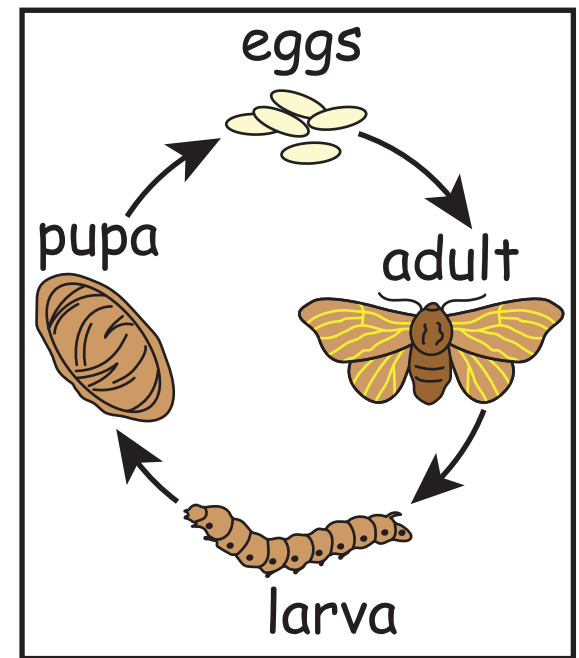
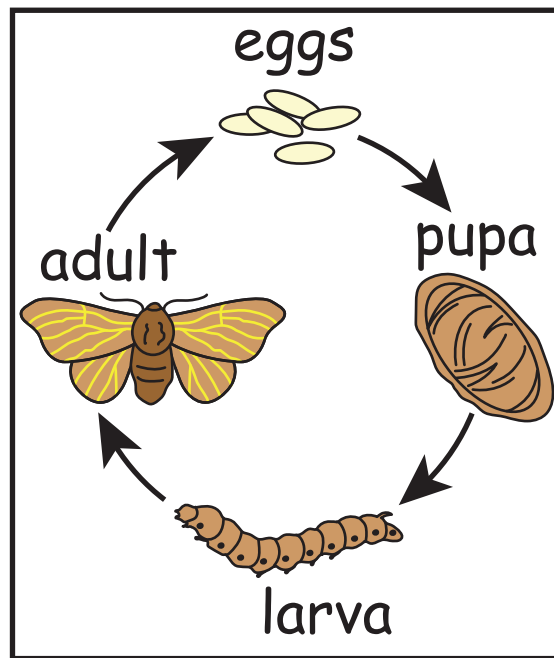
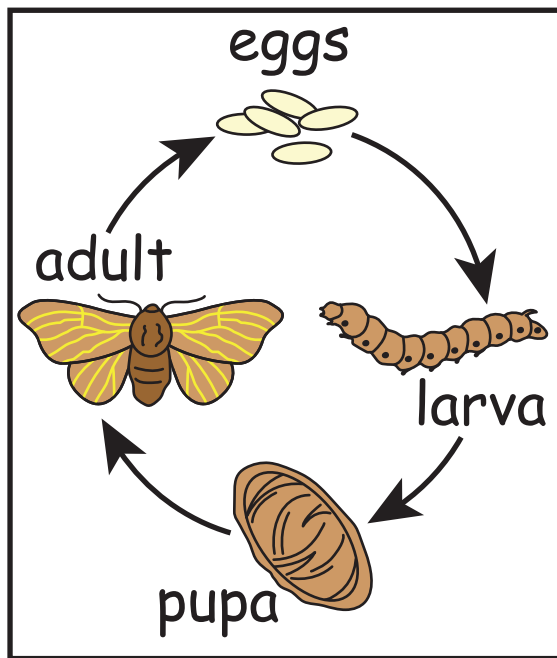



14a



14b

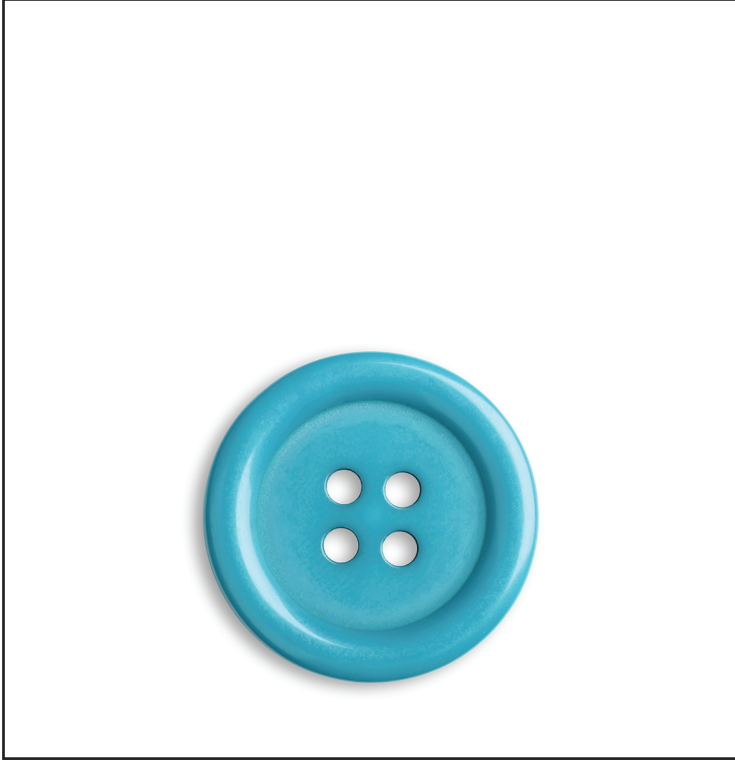

© iStock.com/Rüstem GÜRLER



© iStock.com/skodonnell

15a



© iStock.com/mrgao

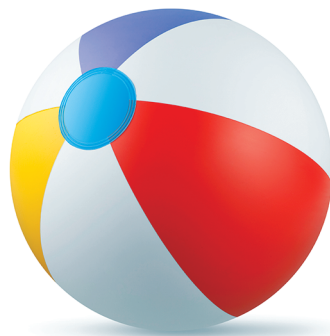

© iStock.com/malerapaso

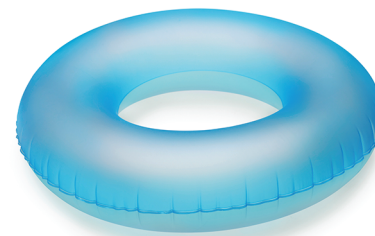

© iStock.com/Coprid

rough

flexible

liquid

Shape

Sphere	Cube
beach ball	number cube
marble	box
	sugar cube

nickel

party hat

globe

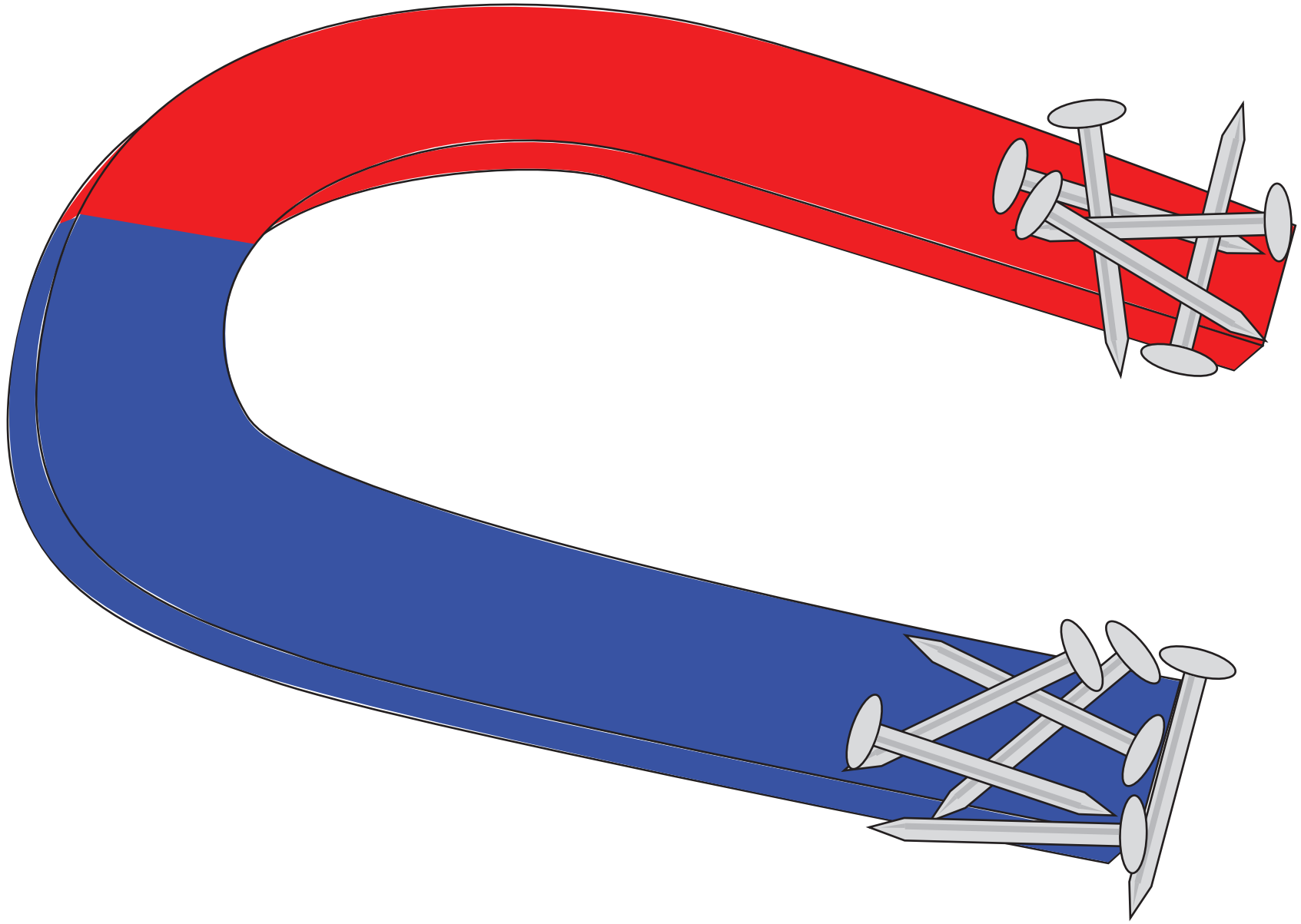

18a

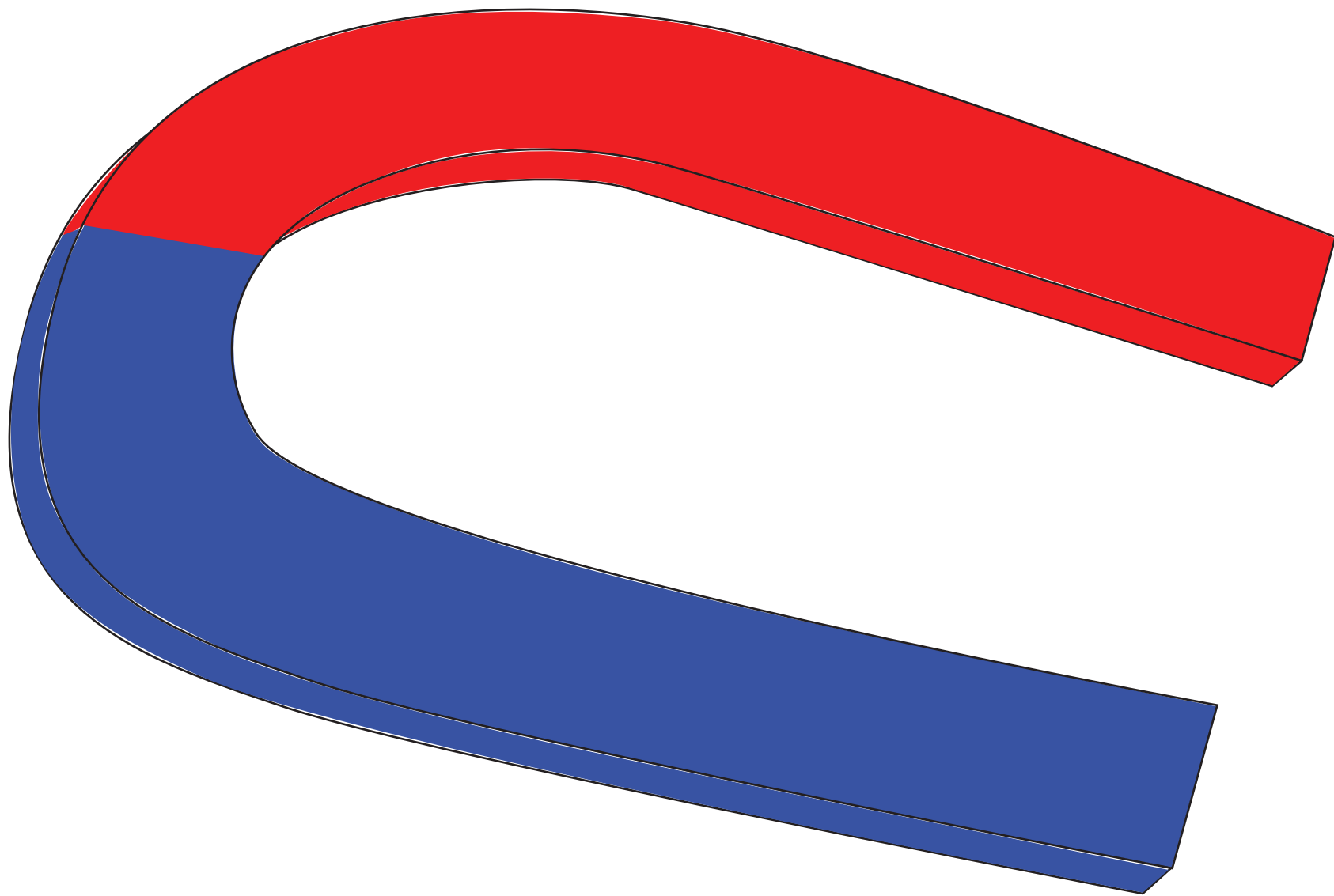

18b

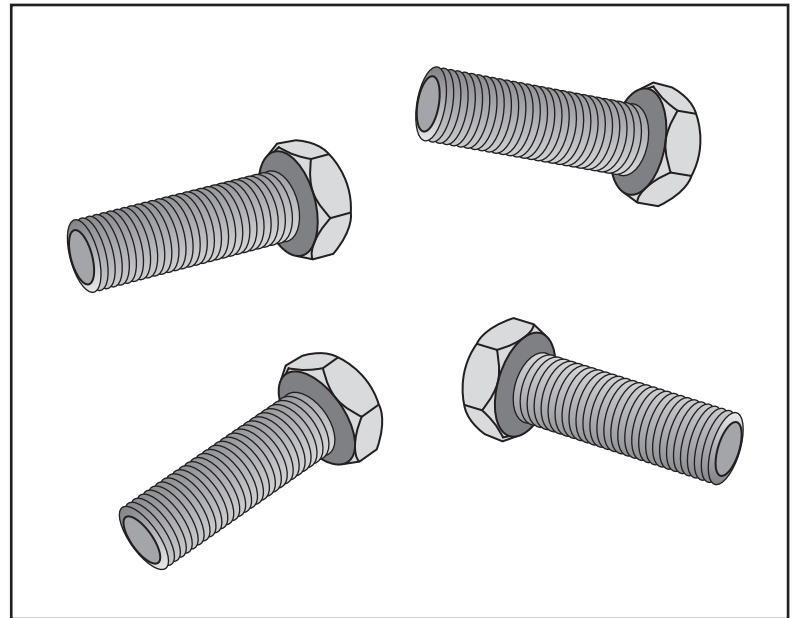
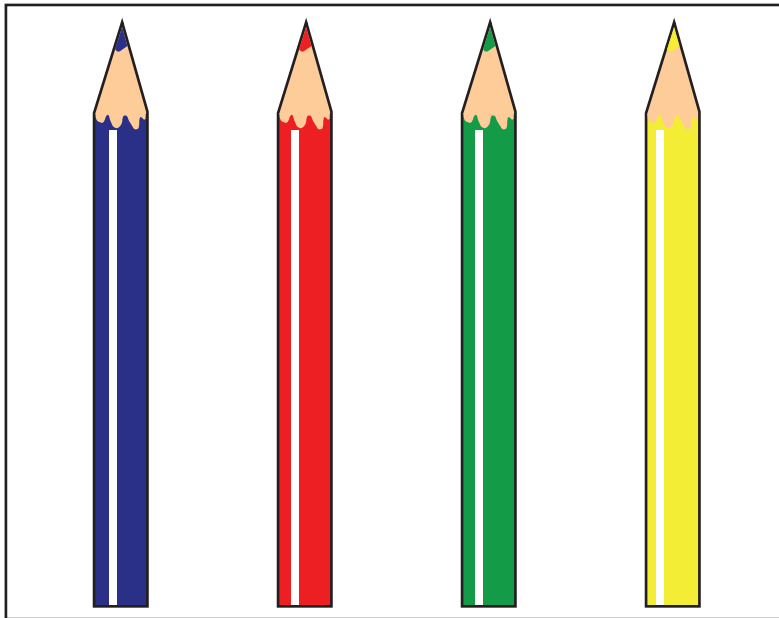

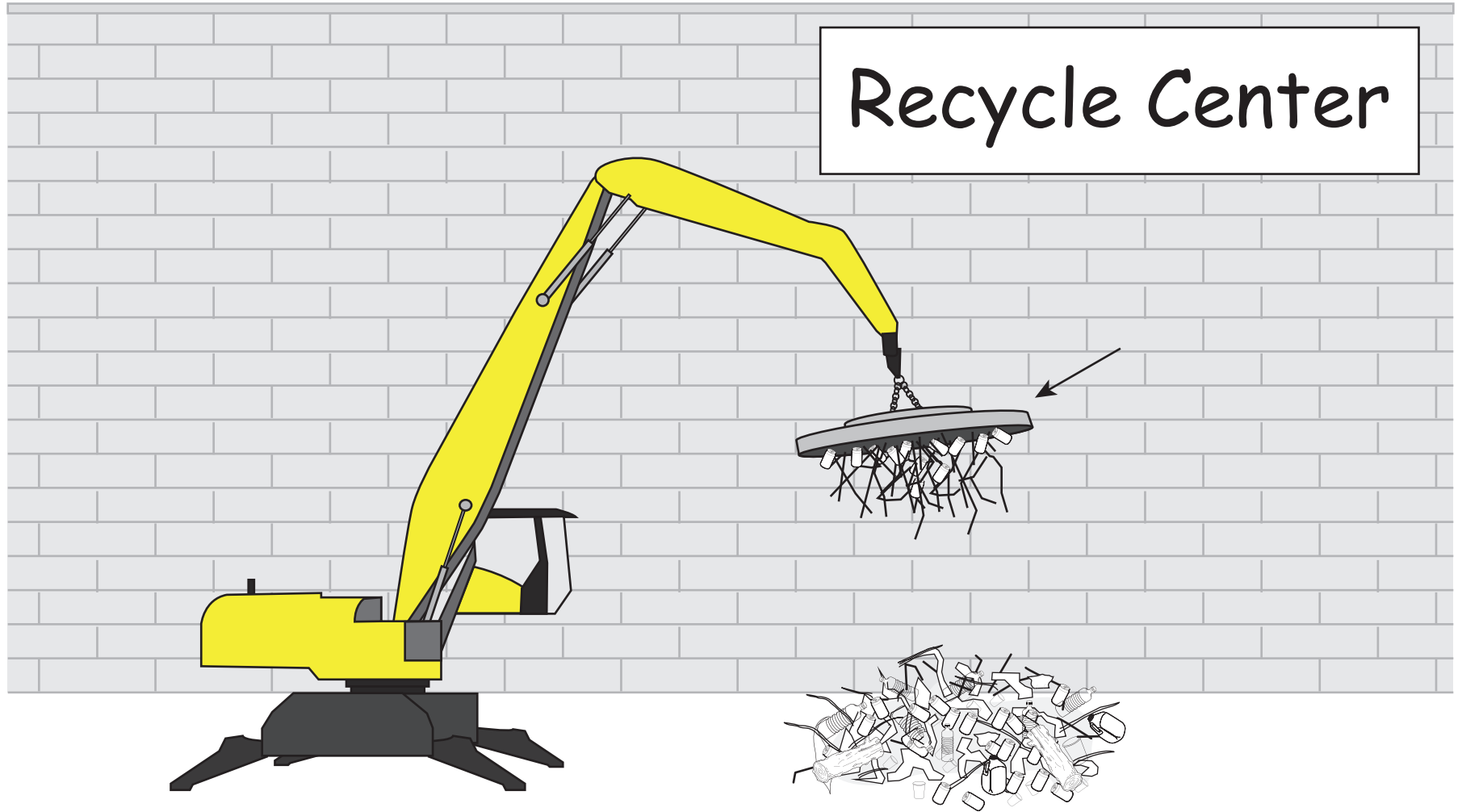

The magnet pulls metal from the pile.

The magnet pulls plastic from the pile.

The magnet drops wood on the pile.

20a



Magnets are used to help a roller coaster move on the track.

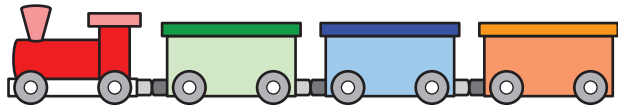

Magnets are used to help a child connect toy train cars.

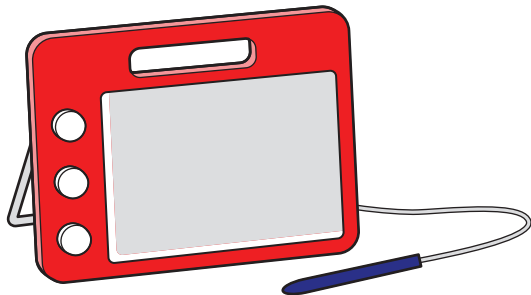

Magnets are used to draw on a magnetic drawing board.

These magnets are used for medical tests.

These magnets are used for fun activities.

These magnets are used to help people do their work.

**STAAR ALTERNATE 2
GRADE 5
Science
April 2019**

ISD21060

Printed in the USA

1 2 3 4 5 A B C D E

1118832